

# 9001 Series

## DIN41612 R Type Male

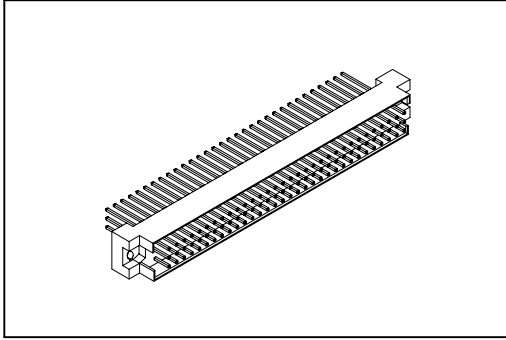

### Material:

Housing: 30% Glass Filled PBT UL94V-0.  
Contacts: Brass.

### Electrical Characteristics:

Current Rating: 2 A.  
Dielectric Withstanding Voltage: AC 1000V.  
Insulator Resistance: 1000M $\Omega$  min.  
Contact Resistance: 30m $\Omega$  max.  
Operating Temperature: -55°C ~+105°C .

### Features:

- \* UL, cUL listing.
- \* Mates with Female 3Row  
9001-1296,1264, C Type.  
9001-1496,1464, R Type.  
9001-1264, IDC Type.

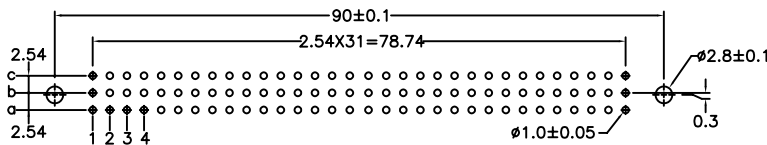
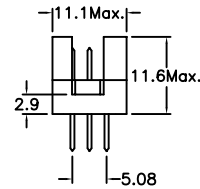
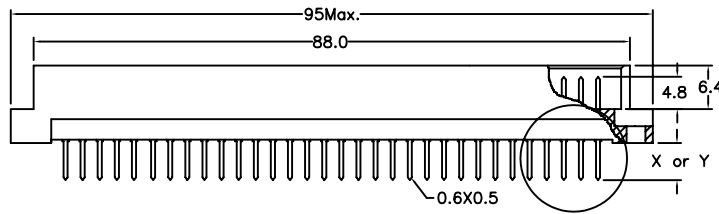
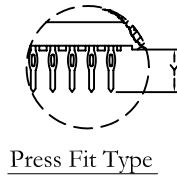
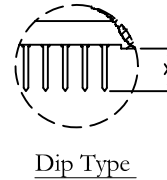
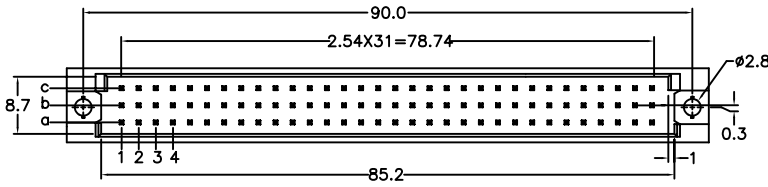

P.C. Board Layout

Length	1	2	W1	W2
X	4.0	2.5	13	17
Y	4.6	6.3	13	17
Pitch	Position	Rows with Contacts	Contact Arrange	
2.54mm	96	a b c		
	64	a - c		
	32	a - -		
5.08mm	48	a b c		
	32	a - c		
	16	a - -		

## Ordering information

9001- 1	3	96	1	C	00	P	L1	A	
Series	1: 2.54mm 2: 5.08mm	3: Male	Position	1: Dip Length 2: Dip Length W1: Dip Length W2: Dip Length	C: Dip Tin Contact Gold G: Gold	00: G/F 10: 10 $\mu$ " 15: 15 $\mu$ " 30: 30 $\mu$ "	Blank: Dip P: Press Fit	Blank: W/O Lock L1: With Lock See Page CA04	A: Tray Package

\*Standard Gold Flash.