

9001 Series

DIN41612 C Type Female

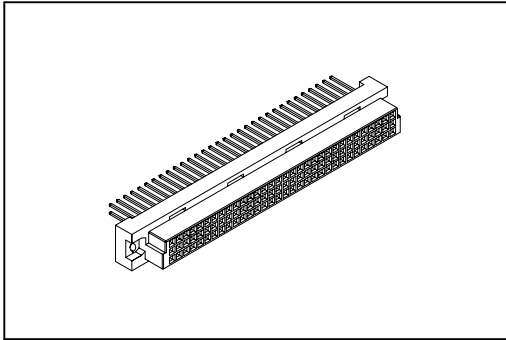

Material:

Housing: 30% Glass Filled PBT UL94V-0.
 Contacts: Phosphor Bronze.

Electrical Characteristics:

Current Rating: 2 A.
 Dielectric Withstanding Voltage: AC 1000V.
 Insulator Resistance: 1000MΩ min.
 Contact Resistance: 30mΩ max.
 Operating Temperature: -55°C ~ +105°C .

Features:

- * UL, cUL listing.
- * Mates with Male 3Row
 9001-1196, 1164 C Type.
 9001-1396, 1364 R Type.

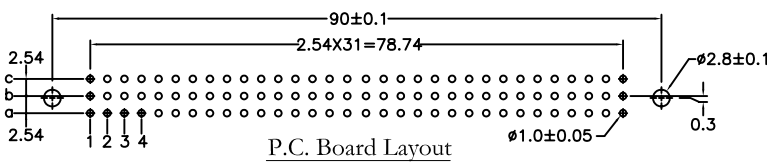
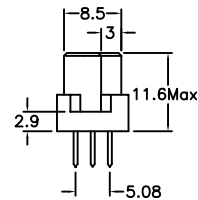
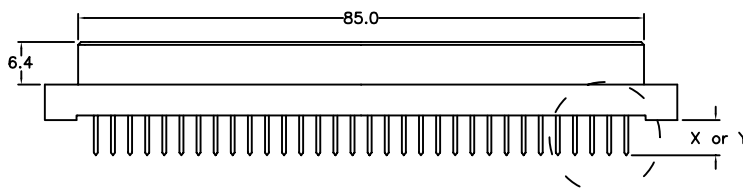
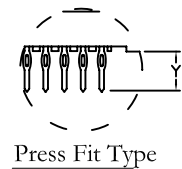
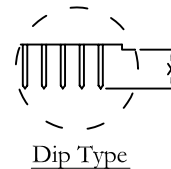
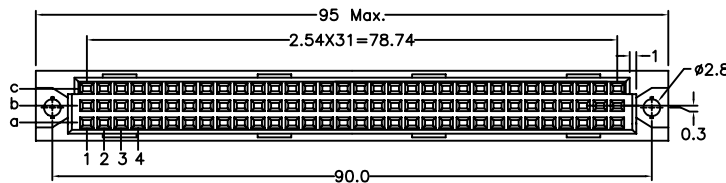

length	1	2	W1	W2
X	4.0	2.5	13	17
Y	4.6	6.3	13	17
Pitch	Position	Rows with Contacts	Contact Arrange	
2.54mm	96	a b c		
	64	a b -		
	64	a - c		
	32	a - -		
5.08mm	48	a b c		
	32	a b -		
	32	a - c		
	16	a - -		

Ordering information

9001-	1	2	96	1	C	00	P	L1	A
Series	1: 2.54mm 2: 5.08mm	2: Female	Position	1: Dip Length 2: Dip Length W1: Dip Length W2: Dip Length	C: Dip Tin Contact Gold G: Gold	00: G/F 10: 10μ" 15: 15μ" 30: 30μ"	Blank: Dip P: Press Fit	Blank: W/O Lock L1: With Lock See Page CA04	A: Tray Package

*Standard Gold Flash.

*32, 64 Pin Standard a - c Row.